

Fuse Holders for 1/4" x 1 1/4" and 5 x 20mm Fuses

HTB Panel Mount Series



Description

- For 1/4" x 1 1/4" and 5 x 20mm fuses
- All holder bodies have the option of using 1/4" x 1 1/4" or 5 x 20mm carriers
- Withstands 15 to 20 Lb-In torque to mounting nut when mounting fuse holder to panel
- High temperature, flame retardant, Thermoplastic meets UL 94V0



Specifications

Product Code	UL Rating (amps)	CSA Rating (amps)	Voltage Rating	Fuse Size	Quick Connect
HTB-X2I	20	16	250	1/4" x 1 1/4"	3/16"
HTB-X4I	20	16	250	1/4" x 1 1/4"	3/16"
HTB-X6I	20	16	250	1/4" x 1 1/4"	1/4"
HTB-X8I	20	16	250	1/4" x 1 1/4"	1/4"
HTB-X2M	16	16	250	5 x 20mm	3/16"
HTB-X4M	16	16	250	5 x 20mm	3/16"
HTB-X6M	16	16	250	5 x 20mm	1/4"
HTB-X8M	16	16	250	5 x 20mm	1/4"

Agency Information

- UL Recognized: IZLT2, E14853
- CSA Component Acceptance: Class 6225-01, File 47235
- VDE Certified: 136128, HTB-XXM
- SEMKO Certification: Ref. #0146149/01, HTB-XXM
- CE

Maximum Panel Thickness

Body Type	Inch	mm
HTB-2	0.30	7.62
HTB-3	0.30	7.62
HTB-4	0.125	3.18
HTB-5	0.125	3.18
HTB-6	0.30	7.62
HTB-8	0.125	3.18
HTB-9	0.125	3.18

Replacement Parts

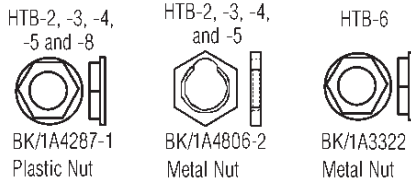

Mounting Dimensions - in (mm)

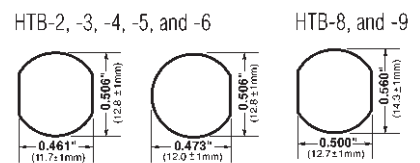







Dimensions - in (mm)

Knob Type Carrier	Maximum Panel Thickness	Terminal Options				Carrier Options	
		Solder/ 3/16" Quick-Connect		1/4" Quick-Connect		1/4" x 1 1/4" ("I" Equals Inches)	5 x 20mm ("M" Equals Metric)
		In-Line	Rt. Angle	In-Line	Rt. Angle	Knob	Knob
Low Profile Rear Hex Nut HTB-2	0.30" 7.62mm					3	—
		HTB-22I-R	HTB-24I-R	HTB-26I-R	HTB-28I-R	—	3
High Profile Rear Hex Nut HTB-4	0.125" 3.18mm					3	—
		HTB-42I-R	HTB-44I-R	HTB-46I-R	HTB-48I-R	—	3
Front Hex Nut HTB-6	0.30" 7.62mm					3	—
		HTB-62I-R	HTB-64I-R	HTB-66I-R	HTB-68I-R	—	3
Low Profile Snap-In HTB-8	0.125" 3.18mm					3	—
		HTB-82I-R	HTB-84I-R	HTB-86I-R	HTB-88I-R	—	3

















Fuseholders and fuse carriers may be ordered separately.

Dimensions - in (mm)

Screwdriver Type Carrier	Maximum Panel Thickness	Terminal Options				Carrier Options	
		Solder/ 3/16" Quick-Connect		1/4" Quick-Connect		1/4" x 1/4" ("I" Equals Inches)	5 x 20mm ("M" Equals Metric)
		In-Line	Rt. Angle	In-Line	Rt. Angle	Screwdriver	Screwdriver
Common Dimensional Data: (Screwdriver Slotted) 1.75" (44.5mm) NOTE: Plus In-Line Terminal							
Low Profile Rear Hex Nut HTB-3	0.30" 7.62mm	HTB-32I-R HTB-32M-R	HTB-34I-R HTB-34M-R	HTB-36I-R HTB-36M-R	HTB-38I-R HTB-38M-R	3 —	— 3
High Profile Rear Hex Nut HTB-5	0.125" 3.18mm	HTB-52I-R HTB-52M-R	HTB-54I-R HTB-54M-R	HTB-56I-R HTB-56M-R	HTB-58I-R HTB-58M-R	3 —	— 3
Low-Profile Snap-In HTB-9	0.125" 3.18mm	HTB-92I-R HTB-92M-R	HTB-94I-R HTB-94M-R	HTB-96I-R HTB-96M-R	HTB-98I-R HTB-98M-R	3 —	— 3

Fuseholders and fuse carriers may be ordered separately.

Ordering Information

																
Packing (Blank) – Std. BK/ – Bulk	Product Symbol	HTB-						S	P	FUSE CARRIER ONLY						
Body Configuration and Mounting Knob Holders 2 – Low Profile (Rear Panel Hex-Nut) 4 – High Profile *6 – (Front Panel Hex-Nut) 8 – Low Profile (Snap-In) Screwdriver Slotted Holders 3 – Low Profile 5 – High Profile 9 – Low Profile (Snap-In)	Rear Terminal Configuration 2 – Solder / 3/16" Quick-Connect (In-Line) 4 – Solder / 3/16" Quick-Connect (Right Angle) 6 – 1/4" Quick-Connect (In-Line) 8 – 1/4" Quick-Connect (Right Angle)									Packing (Blank) – Std. BK/ – Bulk	Product Symbol FT – Knob Type (For 20, 40, 60, and 80 Series Only) ST – Screwdriver Slotted (For 30, 50, and 90 Series Only)	Fuse Carrier I – 1/4" x 1 1/4" M – 5mm x 20mm				

*Profile varies with panel thickness. Holder installs thru rear of panel.

Packaging	
Packaging Code Prefix	Description
Blank	10 fuse holders packed into a carton
BK	100 fuse holders packed into a cardboard shelf package

The only controlled copy of this Data Sheet is the electronic read-only version located on the Cooper Bussmann Network Drive. All other copies of this document are by definition uncontrolled. This bulletin is intended to clearly present comprehensive product data and provide technical information that will help the end user with design applications. Cooper Bussmann reserves the right, without notice, to change design or construction of any products and to discontinue or limit distribution of any products. Cooper Bussmann also reserves the right to change or update, without notice, any technical information contained in this bulletin. Once a product has been selected, it should be tested by the user in all possible applications.

Life Support Policy: Cooper Bussmann does not authorize the use of any of its products for use in life support devices or systems without the express written approval of an officer of the Company. Life support systems are devices which support or sustain life, and whose failure to perform, when properly used in accordance with instructions for use provided in the labeling, can be reasonably expected to result in significant injury to the user.

© 2009 Cooper Bussmann
St. Louis, MO 63178
www.cooperbussmann.com

